

MAX!

Radiator Thermostat+



Operating manual

BC-RT-TRX-CyG-4

Scope of delivery

Quantity	Item
1x	MAX! Radiator Thermostat ⁺
1x	Danfoss RA adapter
1x	Danfoss RAV adapter
1x	Danfoss RAV tappet extension
1x	Danfoss RAVL adapter
1x	Cylinder head screw M4 x 12 mm, nut M4
1x	Support ring
2x	LR6/mignon/AA battery
3x	Brief instruction in German/English, French/Dutch and Polish/Italian

Table of contents

1	Information about this manual.....	4
2	Safety instructions	4
3	Function	5
4	Device overview.....	7
5	Start-up.....	8
6	Teaching-in	19
7	Operating modes (Auto/manu/holiday)	23
8	Comfort and reduction temperature	24
9	Setting the holiday function	25
10	Configuration menu	26
11	Child safeguard/operating lock	40
12	Activate heating pause (battery saving).....	43
13	Restore factory settings.....	44
14	LED flashing sequences and transmission behaviour	45
15	Maintenance and cleaning.....	46
16	Information about radio operation	47
17	Technical specifications.....	48

1 INFORMATION ABOUT THIS MANUAL

Read this manual carefully before starting to use the device. Keep the manual so you can refer to it at a later date if you need to. If you hand over the device to other persons for use, please hand over the operating manual as well.

Symbols used:



Attention!

This indicates a hazard.



Note.

This section contains important additional information.

2 SAFETY INSTRUCTIONS



The device is not a toy; do not allow children to play with it. Do not leave packaging material lying around, as it can be dangerous in the hands of a child.



Do not open the device: it does not contain any components that need to be serviced by the user. In the event of an error, please return the device to the service department.



The device may only be operated indoors and must be protected from the effects of damp and dust, as well as solar or heat radiation.



Using the device for any purpose other than that described in this operating manual does not fall within the scope of intended use and shall invalidate any warranty or liability. This also applies to any conversion or modification work. The device is intended for private use only.

3 FUNCTION

The MAX! Radiator Thermostat+ is responsible for regulating the radiators within the MAX! system. During ventilation, the MAX! Radiator Thermostat+ automatically reduces the temperature in a room in order to save on energy costs. Communication between the MAX! components is bidirectional. This ensures that the information sent reaches the recipient.

The configuration of the MAX! Radiator Thermostat+ is made according to the system variant used. You have the possibility to choose between the following three variants:



MAX! House solution

This is the solution for the entire house. With a MAX! Cube, all settings of connected devices in the house can comfortably be made via the MAX! software. By using the MAX! Cube, several MAX! Radiator solutions and MAX! Room solutions can be connected to a MAX! House solution in a new installation.



MAX! Room solution

In the room solution, the settings of all connected devices in your room can comfortably be made via the MAX! Wall Thermostat+. Up to 8 MAX! Radiator Thermostats+ and 8 MAX! Window Sensors can be connected and controlled via the MAX! Wall Thermostat+. With a MAX! Cube, the solution can be extended to a House solution.



MAX! Radiator solution

With the MAX! Radiator solution you can easily start using the MAX! system. The ambient temperature within a room can be flexibly controlled and regulated with up to 2 MAX! Radiator Thermostats+ and 3 MAX! Window Sensors. Configuration is performed directly on the MAX! Radiator Thermostat+.

With a MAX! Wall Thermostat+, the solution can be extended to a room solution, with a MAX! Cube it can be extended to a House solution.

4 DEVICE OVERVIEW

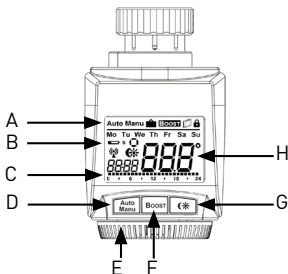

A	Automatic mode (Auto), manual mode (Manu), holiday mode (☞), Boost function (BOOST), open-window function (☞), operating lock (🔒)
B	Weekday, replace batteries of the Radiator Thermostat+ (🔋), replace batteries of a taught-in device (e.g. window sensor) (🔋), radio activity (📶), comfort/reduction temperature (☞), time/date, activity symbol (👤)
C	Bar chart of programmed heating phases of current day
D	Auto/Manu button: Switch between automatic and manual mode, exit the holiday mode
E	Handwheel for temperature settings, select and set menu items
F	Boost button: Activate the boost function, confirm, start teach-in procedure
G	Switch between reduction and comfort temperature
H	Display of setpoint temperature

4.1 DISPLAY CONTENT IN NORMAL MODE

Operating mode, week day, setpoint temperature, time, radio signal and switching time periods are displayed in normal mode. In the example, the MAX! Radiator Thermostat+ is in automatic mode (**Auto**) and the comfort temperature (☀) of 21.0°C is set. The weekday Tuesday (Tu) and the time (19:07 h) are displayed. The antenna symbol (📶) indicates that the connection to the taught-in components has been established. The heating phases are displayed as bar charts.

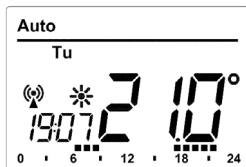

The bars for the heating phases in the week program will only be displayed if the saved temperature is higher than the reduction temperature. Please see section 10.1 for examples.

5 START-UP

5.1 INSERTING (REPLACING) BATTERIES

To insert the batteries into the MAX! Radiator Thermostat+, please proceed as follows:

- Remove the battery compartment cover by pushing it forwards.
- Insert 2 LR06/mignon/AA batteries in the battery compartment, making sure they are the right way round.
- Reattach the battery compartment cover and latch it into place.

After inserting batteries, the radiator thermostat has to be mounted on the radiator (see sec. „5.3 Installation on the radiator“ on page 10). The radiator thermostat starts an adapting run afterwards (see sec. „5.4 Adapting run“ on page 18).

A battery symbol () indicates that the batteries need to be replaced. After removing the batteries, you should wait approx. 1 minute before inserting the new ones.

 The service life of new alkaline batteries is approximately two years.

 This device does not support operation with rechargeable batteries.

 Never recharge standard batteries. Doing so will present a risk of explosion. Do not throw the batteries into a fire! Do not short-circuit batteries.



Used batteries should not be disposed of with regular domestic waste! Instead, take them to your local battery disposal point.

5.2 SET DATE AND TIME

If batteries are inserted or replaced, the date and time is automatically requested after a brief display of the firmware version number:

- Set the year, month, day, hour and minute with the hand-wheel and confirm with the Boost button. The motor moves the control pin backwards during the setting of date and time.
- If "InS" and the rotating activity symbol  are displayed, the motor still reverses. When only "InS" is shown in the display, the radiator thermostat can be installed on the valve.

The MAX! Radiator Thermostat+ can be configured already before installation. Press the auto/menu button for this, while „INS“ is shown in the display (see sec. „10 Configuration menu“ on page 26). After the programming has been completed, „InS“ is shown again in the display and installation can take place.

5.3 INSTALLATION ON THE RADIATOR

The MAX! Radiator Thermostat+ is easy to install and can be done without draining heating water or intervening in the heating system. No special tools are required, nor does the heating have to be switched off.

The union nut attached to the radiator thermostat can be used universally and without accessories for all valves with a thread size of M30 x 1.5 from the most popular manufac-

turers such as

- Heimeier
- MNG
- Junkers
- Landis&Gyr (Duodyr)
- Honeywell-Braukmann
- Oventrop
- Schlösser
- Comap
- Valf Sanayii
- Mertik Maxitrol
- Watts
- Wingenroth (Wiroflex)
- R.B.M
- Tiemme
- Jaga
- Siemens
- Idmar

By means of the adapters in the delivery, the device can be installed on radiator valves of type Danfoss RA, Danfoss RAV and Danfoss RAVL.

5.3.1 Removing the old dial

Rotate the thermostat dial to the maximum value (1) (anti-clockwise). The thermostat dial then no longer presses against the valve spindle, making it easier to remove. There are different ways of fixing the position of the thermostat dial:

- **Union nut:** Unscrew the union nut in an anticlockwise direction (2). The thermostat head can then be removed (3).
- **Snap-on fastenings:** Thermostat dials that have been attached using this method can be easily released by giving the lock/union nut a slight turn in the anticlockwise direction (2). The thermostat head can then be removed (3).
- **Compression fitting:** The thermostat dial is held in place by a mounting ring which is held together with a screw. Loosen this screw and remove the thermostat head from the valve (3).
- **Threaded connection with set screw:** Loosen the set screw and remove the thermostat head (3).

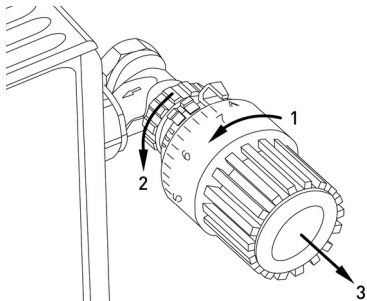

5.3.2 Adapter for Danfoss

One of the provided adapters is needed to attach to Danfoss valves. The assignment of the suitable adapter ring to the relevant valve can be found in the following illustrations.



Please ensure that you do not trap your fingers between the two halves of the adapter!

The Danfoss valve bodies have elongated notches (I) around their circumference (see arrow), which also ensure that the adaptor is properly seated when it snaps on.

During installation, please ensure that the pins inside the adapter (J) are lined up with the notches (I) on the valve.

Ensure that a suitable adapter for the valve is properly clipped on.

The RA and RAV adapters have been manufactured with pre-tension in order to provide a better seat. Use a screwdriver during installation if necessary, and bend it open slightly in the vicinity of the screw. After clipping onto the valve body, please attach the adapter using the provided screw and nut.

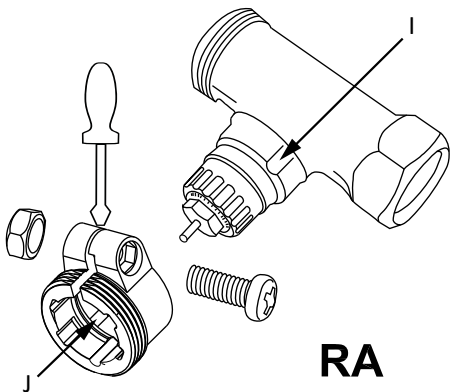

RA



During installation, please ensure that the pins inside the adapter (J) are lined up with the notches (I) on the valve.

Ensure that a suitable adapter for the valve is properly clipped on.

The lifter extension (K) must be fitted to the valve pin of RAV valves prior to installation.

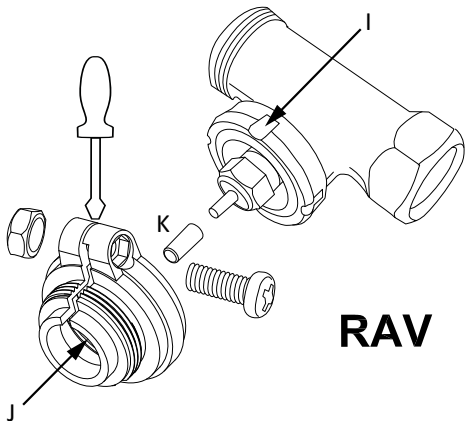

RAV



During installation, please ensure that the pins inside the adapter (J) are lined up with the notches (I) on the valve.

Ensure that a suitable adapter for the valve is properly clipped on.

The adapter RAVL does not have to be screwed.

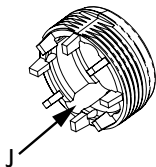
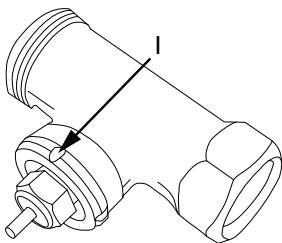



RAVL

5.3.3 Support ring

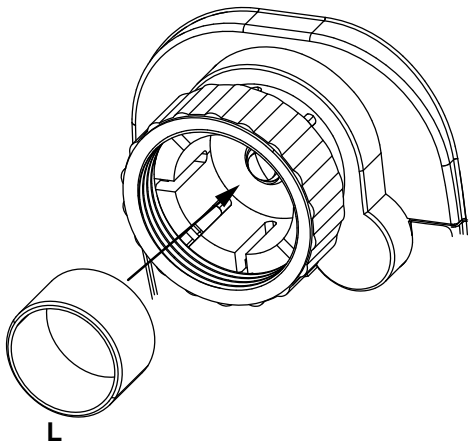
The valves from different manufacturers may have tolerance fluctuations that make the radiator thermostat more loosely seated on the valve. In this case, the provided support ring (L) should be placed into the flange before mounting the radiator thermostat.





5.4 ADAPTING RUN

Once the batteries have been inserted and date and time have been set, the motor reverses; meanwhile, "InS" and the activity symbol () are displayed. As soon as "InS" is displayed without the activity symbol () , the radiator thermostat⁺ can be mounted. This is followed by an adapting run ("AdA") to adapt the thermostat to the valve.

- Attach the radiator thermostat to the valve (see sec. „5.3 Installation on the radiator“ on page 10).
- Tighten the union nut.
- Press the Boost button when "InS" is displayed.

Now the radiator thermostat performs an adapting run. "AdA" and the activity symbol () are displayed; during this time, operation is not possible.

If the adapter run has been initiated prior to mounting or if an error message (F1, F2, F3) is displayed, press the Boost button; the motor reverses to the "InS" position.

-  Teach-in mode can be activated even whilst "InS" is still displayed.
-  If the MAX! Radiator Thermostat⁺ has not been taught-in to the MAX! Cube, the device automatically switches to manual operation (Manu).

6 TEACHING-IN

In order to be able to use the MAX! Radiator Thermostat+ in your installation, you must teach it in first. The teach-in procedure depends on the system variant used. Choose your system variant (House, Room or Radiator solution) and follow the instructions below.



MAX! House solution

In the MAX! House solution all settings and program-mings (e.g. week programs) can be made via the **MAX! software**. To teach-in the device to the MAX! Cube, proceed as follows:

- Put the MAX! Cube into teach-in mode. Start the local MAX! software and click on "New device" (1).
- To activate teach-in mode on the MAX! Radiator Thermostat+, press and hold down the Boost button for at least 3 seconds. The display shows the remaining teach-in time in seconds. The teach-in time is 30 seconds.

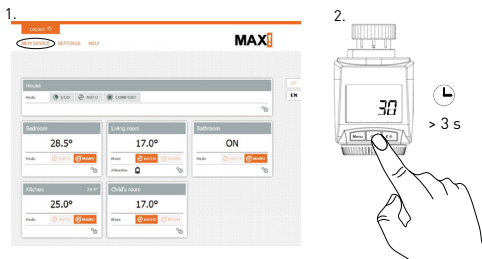

- After teaching-in has been successful, the display returns back to normal display.

i As soon as the MAX! Radiator Thermostat+ has been taught-in to a MAX! Cube, all settings will be transmitted via radio.

i The MAX! Radiator Thermostat+ can only be taught-in to one MAX! Cube.

i If the MAX! Radiator Thermostat+ has already been configured via a MAX! Wall Thermostat+, a factory reset has to be performed before teaching-in the device to a MAX! Cube (see sec. „13 Restore factory settings“ on page 44).



MAX! Room solution

In the MAX! Room solution all settings and programmings (e.g. week programs) can be made directly via

the **MAX! Wall Thermostat+**. To teaching-in the device to the MAX! Wall Thermostat+, proceed as follows:

- Press and hold down the OK button of the MAX! Wall Thermostat+ for at least 3 seconds to activate teach-in mode (1).
- Activate the teach-in mode of your MAX! Radiator Thermostat+. Press and hold down the Boost button for at least 3 seconds. The display shows the remaining teach-in time in seconds. The teach-in time is 30 seconds.

1.

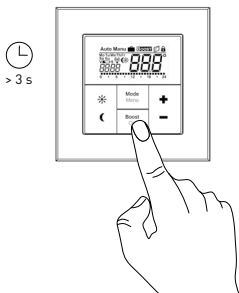

2.

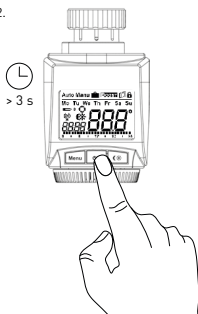

After teaching-in has been successful, the display returns back to normal display.



MAX! Radiator solution

In the MAX! Room solution all settings and programmings (e.g. week programs) can be made directly via the **MAX! Radiator Thermostat+**.

All devices have to be taught-in to each other, i.e. is all MAX! Radiator Thermostats+ and all MAX! Window Sensors have to be taught-in to each other (max. 7 connections).

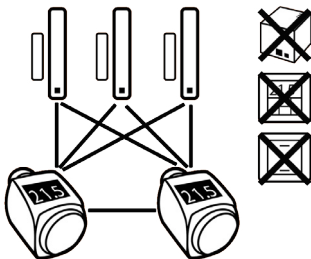

If you have already taught-in and configured a MAX! Radiator Thermostat+ and want to add another MAX! Radiator Thermostat+ you first have to activate teach-in mode of the device you have already configured. The configuration data will then be transmitted automatically to the new device.

- Put the MAX! Window Sensor into teach-in mode according to the corresponding operating manual.

- Activate the teach-in mode of your MAX! Radiator Thermostat+. Press and hold down the Boost button for at least 3 seconds. The display shows the remaining teach-in time in seconds. The teach-in time is 30 seconds.

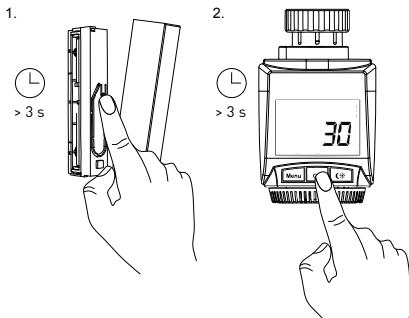

- After teaching-in has been successful, the display returns back to normal display.

7 OPERATING MODES (AUTO/MANU/HOLIDAY)

To switch between operating modes, press and immediately release the Auto/Manu button (the operating modes only become available for selection once installation is complete).

- **Auto:** Week program - automatic temperature regulation

in accordance with the time profile saved (heat/reduce).

- **Manu:** Manual operation - the manually set temperature using the handwheel is maintained permanently.
- **Holiday (👛):** In holiday mode, the set temperature is maintained up to an end time, at which point the device switches to auto mode automatically.



If the operating mode is changed on one device in a room, this change is applied to all taught-in MAX! Radiator Thermostats assigned to that room.

8 COMFORT AND REDUCTION TEMPERATURE

The comfort and reduction temperature button (☼) makes switching between comfort and reduction temperature simple and user friendly. The factory setting for the comfort temperature is 21.0 °C and the reduction temperature 17.0 °C. The comfort and reduction temperature can be changed individually.



In the MAX! House solution you can configure the settings for the MAX! Radiator Thermostat+ via the MAX! software.



In the MAX! Room solution you can configure the settings for the MAX! Radiator Thermostat+ via the MAX! Wall Thermostat+.



If you use the MAX! Radiator Thermostat+ in the MAX! Radiator solution, proceed as follows:

- Press and hold the comfort/reduction temperature button (☀) for at least 3 seconds.
- The display shows the symbol (☀) and the comfort temperature as defined.
- Change the temperature with the handwheel and confirm with the Boost button.
- The display shows the symbol (☾) and the reduction temperature as defined.
- Change the temperature with the handwheel and confirm with the Boost button.

Even in auto mode, the temperature can be changed at any time using the button. It will then remain the same until the next point at which the week programme changes.

9 SETTING THE HOLIDAY FUNCTION

If you want to maintain a fixed temperature for a certain period, e.g. during your holidays or a party, the holiday function can be used.



In the MAX! House solution you can configure the settings for the MAX! Radiator Thermostat+ via the MAX! software.



In the MAX! Room solution you can configure the settings for the MAX! Radiator Thermostat+ via the MAX! Wall Thermostat+.



If you use the MAX! Radiator Thermostat+ in the MAX! Radiator solution, proceed as follows:

- Briefly press the Auto/Manu button repeatedly, until the suitcase symbol (🧳) appears in the display.
- Set the time via the handwheel up to which the temperature is to be maintained and then confirm with the Boost button.
- Set the weekday via the handwheel up to which the temperature is to be maintained and then confirm with the Boost button.
- Set the temperature with the handwheel and confirm with the Boost button. The display will flash to confirm.

The set temperature will remain until the set end time. Afterwards the radiator thermostat will switch back to Auto mode. Radio control commands like those from a MAX! Window Sensor or the routine descaling run will still be performed.

10 CONFIGURATION MENU



As soon as the MAX! Radiator Thermostat+ has been taught-in to the MAX! Cube, all settings have to be made via the MAX! software. Opening the menu of the MAX! Radiator Thermostat+ is no longer possible.



As soon as the MAX! Radiator Thermostat+ has been taught-in to a MAX! Wall Thermostat+, all settings have to be made via the MAX! Wall Thermostat+. Opening the menu of the MAX! Radiator Thermostat+ is no longer possible.



MAX! Radiator solution

Settings of the MAX! Radiator Thermostat+ can be changed in the configuration menu of the device. The menu can be accessed by pressing the Auto/Mode button for more than 3 seconds. Menu items can be selected with the handwheel and confirmed with the Boost button. By pressing the Auto/Menu button again, you can return to the previous level. If there is no further activation of the device for more than 1 minute, the menu closes automatically. The following settings can be made:

Section	Display	Function
14.1	Pro:	Set week program
14.2	dAT:	Change time and date
14.3	bOS:	Set valve opening and length of "Boost" function
14.4	AEr:	Set open-window temperature and time for the automatic temperature reduction during ventilation
14.5	dEC:	Set valve protection function
14.6	t-d:	Changing display of date and time
14.7	dSt:	[De-)Activate automatic switching between summer and winter time

- 14.8 tOF: Set temperature offset
- 14.9 UnL: Teach-out wireless components
- 14.10 rES: Restoring the factory settings

10.1 SETTING THE WEEK PROGRAM (PRO)

In the week program, for each weekday up to 6 heating phases (13 change settings) can be set separately. The programming is carried out for the days chosen, whereby temperature settings have to be set for the entire period between 00:00 and 23:59.



In the MAX! House solution you can configure the settings for the MAX! Radiator Thermostat+ via the MAX! software.



In the MAX! Room solution you can configure the settings for the MAX! Radiator Thermostat+ via the MAX! Wall Thermostat+.



If you use the MAX! Radiator Thermostat+ in the MAX! Radiator solution, proceed as follows:

- Press the Auto/Manu button longer than 3 seconds. The display will show "Pro". Confirm with the Boost button.
- "dAy" appears on the display. With the handwheel you can be selected an individual weekday, all working days, the weekend or the whole week (example working days).

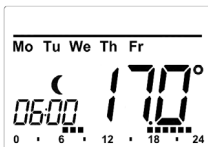

- Confirm with the Boost button.
- Now set the end time of the first time period (example: 6:00 h for the period 0:00 – 6:00 h).
- Confirm with the Boost button.
- With the handwheel select the chosen temperature for the previously chosen time period (example: 17.0°C).
- Confirm with the Boost button.
- Repeat this procedure until temperatures are stored for the entire period between 0:00 and 23:59 h.

In auto mode, the temperature can be changed at any time using the handwheel or the comfort/reduction temperature button (☼). The modified temperature will then remain the same until the next point at which the program changes.

Week program: Example

For each day of the week up to 6 heating phases (13 change settings) with individual temperature settings can be saved with the MAX! Radiator Thermostat+. The factory settings are as follows:

from 00:00 to	06:00	17.0 °C
from 06:00 to	09:00	21.0 °C
from 09:00 to	17:00	17.0 °C
from 17:00 to	23:00	21.0 °C
from 23:00 to	23:59	17.0 °C

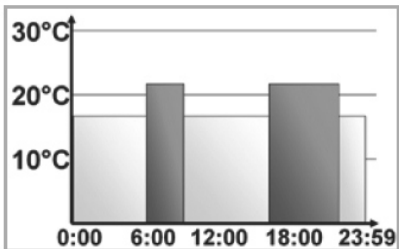

The display will show bars for those heating phases where the set temperature for the period is higher than the saved reduction temperature. With this example no bars for the interval 0:00 to 6:00 are displayed. The bars only appear in the display for the intervals 6:00 to 9:00 and 17:00 to 23:00.

10.2 CHANGING DATE AND TIME (dAT)

In the configuration menu, date and time can be adjusted.



In the MAX! House solution you can configure the settings for the MAX! Radiator Thermostat+ via the MAX! software.



In the MAX! Room solution you can configure the settings for the MAX! Radiator Thermostat+ via the MAX! Wall Thermostat+.



If you use the MAX! Radiator Thermostat+ in the MAX! Radiator solution, proceed as follows:

- Press the Auto/Manu button longer than 3 seconds.
- Select the menu item „dAT“ with the handwheel.
- Confirm with the Boost button.
- Set the year, month, day, hour and minute with the handwheel and confirm with the Boost button.

10.3 BOOST FUNCTION (BOS)

With the boost function, cool rooms can be heated within short at the touch of a button. When the function is activated, the heating valve opens immediately for 5 minutes at 80 % (factory setting). There will be a pleasant room temperature right away because of the radiated heat. By the end of the 5 minute Boost phase, the radiator thermostat automatically changes back to the prior operating mode.

Activate boost function:

- Press the Boost button to activate the boost function.
- The remaining time for the function is counted down in seconds ("300" to "000"). Whilst the function is active, **BOOST** is displayed.
- The activity symbol () is displayed as long as the adjusting pin opens/closes the valve.
- Once the set time has elapsed, the MAX! Radiator Thermostat+ switches back to the mode that was active previously (Auto/Manu), with the temperature that was set previously.
- The function can be deactivated prematurely at any time by pressing the Boost button again.

Adjust duration of boost function and valve opening.



In the MAX! House solution you can configure the settings for the MAX! Radiator Thermostat+ via the MAX! software.



In the MAX! Room solution you can configure the settings for the MAX! Radiator Thermostat+ via the MAX! Wall Thermostat+.



If you use the MAX! Radiator Thermostat+ in the MAX! Radiator solution, proceed as follows:

- Press the Auto/Manu button longer than 3 seconds.
- Select the menu item "bOS" with the handwheel.
- Confirm with the Boost button.
- Set the duration of the boost function (in minutes) with the handwheel and confirm with the Boost button.

- Set the valve opening (in percentage) with the handwheel and confirm with the Boost button.



The radiant heat will not have an immediate effect if the radiator is covered or concealed (e.g. by a sofa).



If the duration of the boost function is set so that the display exceeds 999 seconds, the display value switches from seconds to minutes.

10.4 OPEN-WINDOW FUNCTION (AER)

During ventilation, the MAX! Radiator Thermostat+ automatically reduces the temperature in a room in order to save on energy costs. Whilst this function is active, the open-window symbol () appears on the display.

Without MAX! Window Sensor:

The MAX! Radiator Thermostat+ is able to automatically detect a sharp fall in temperature caused by ventilation (temperature fall detection). The temperature is then reduced to 12 °C for 15 minutes (default factory setting) or to an individually configured value.

With MAX! Window Sensor:

When a MAX! Window Sensor is used, the opening and closing of a window is detected at the precise time it occurs. Whilst the window is open the temperature of all radiator thermostats installed in the room is reduced for 15 minutes to 12°C (default factory setting) or to an individually configured

value. When the MAX! Window Sensor detects the closing of the window, all MAX! Radiator Thermostats installed in the room are immediately reset to their original mode.

Adjust reduced temperature and duration:

A reduced temperature of 12° C and a duration of 15 minutes is set as default. Both values can be configured individually:



In the MAX! House solution you can configure the settings for the MAX! Radiator Thermostat+ via the MAX! software.



In the MAX! Room solution you can configure the settings for the MAX! Radiator Thermostat+ via the MAX! Wall Thermostat+.



If you use the MAX! Radiator Thermostat+ in the MAX! Radiator solution, proceed as follows:

- Press the Auto/Manu button longer than 3 seconds.
- Select the menu item "AER" with the handwheel.
- Confirm with the Boost button.
- Set the reduction temperature with the handwheel and confirm with the Boost button.
- Set the duration for the reduction temperature with the handwheel and confirm with the Boost button.



Temperature fall detection without a MAX! Window Sensor can also be deactivated (by setting the duration to 0 minutes).



When a MAX! Window Sensor is taught-in, the MAX! Radiator Thermostat+ does not react to a temperature fall.

10.5 SETTING ROUTINE DESCALING (dEC)

The MAX! Radiator Thermostat+ can protect against valve calcification automatically. Therefore, an automatic routine descaling is performed once a week. During this brief period, when the valve opens and closes once, operation is not possible. The time for performing this function can individually be configured (it is factory set to run at 12:00 on Saturdays).



In the MAX! House solution you can configure the settings for the MAX! Radiator Thermostat+ via the MAX! software.



In the MAX! Room solution you can configure the settings for the MAX! Radiator Thermostat+ via the MAX! Wall Thermostat+.



If you use the MAX! Radiator Thermostat+ in the MAX! Radiator solution, proceed as follows:

- Press the Auto/Manu button longer than 3 seconds.
- Select the menu item "dEC" with the handwheel.
- Confirm your setting using the Boost button.
- Use the handwheel to select the weekday and confirm this with the Boost button.
- Use the handwheel to select the time and confirm this with the Boost button.



"CAL" is displayed during descaling.

10.6 SWITCHING TIME/DATE DISPLAY (T-D)

The factory setting will show the time on the display. In the menu the display can be switched to the date.



In the MAX! House solution you can configure the settings for the MAX! Radiator Thermostat+ via the MAX! software.



In the MAX! Room solution you can configure the settings for the MAX! Radiator Thermostat+ via the MAX! Wall Thermostat+.



If you use the MAX! Radiator Thermostat+ in the MAX! Radiator solution, proceed as follows:

- Press the Auto/Manu button longer than 3 seconds.
- Select the menu item "t-d" with the handwheel.
- Confirm with the Boost button.
- Now set the format you want to show on the display by turning the handwheel. Date and time will switch when turning the wheel.
- Confirm with the Boost button.

10.7 SWITCHING BETWEEN SUMMER AND WINTER TIME (dSt)

You can activate/deactivate automatic switch-over for summer/winter time for the MAX! Radiator Thermostat+.



In the MAX! House solution you can configure the settings for the MAX! Radiator Thermostat+ via the MAX! software.



In the MAX! Room solution you can configure the settings for the MAX! Radiator Thermostat+ via the MAX! Wall Thermostat+.



If you use the MAX! Radiator Thermostat+ in the MAX! Radiator solution, proceed as follows:

- Press the Auto/Manu button longer than 3 seconds.
- Select the menu item „dSt” with the handwheel.
- Confirm your setting using the Boost button.
- Set the option „On” to activate automatic switching or set the option „OFF” to deactivate automatic switching with the handwheel.
- Confirm with the Boost button.

10.8 SETTING OFFSET TEMPERATURE (TOF)

As the temperature is measured on the radiator, the temperature distribution can vary throughout a room. To adjust this, a temperature offset of ± 3.5 °C can be set. If a nominal temperature of e.g. 20 °C is set but the room presents with only 18 °C, an offset of -2.0 °C needs to be set.



If you use the MAX! Radiator Thermostat+ in connection with a MAX! Wall Thermostat+, the temperature will be measured at the MAX! Wall Thermostat.



In the MAX! House solution you can configure the settings for the MAX! Radiator Thermostat+ via the MAX! software.



In the MAX! Room solution you can configure the settings for the MAX! Radiator Thermostat+ via the MAX! Wall Thermostat+.



If you use the MAX! Radiator Thermostat+ in the MAX! Radiator solution, proceed as follows:

- Press the Auto/Manu button longer than 3 seconds.
- Select the menu item „tOF” with the handwheel and confirm with the Boost button.
- Turn the handwheel and set the desired offset temperature (max. $\pm 3.5^{\circ}\text{C}$).
- Confirm with the Boost button.

10.9 TEACH-OUT WIRELESS COMPONENTS (UnL)

Devices that are taught-in to the MAX! Radiator Thermostat+ can be taught-out with the function “Unlearn” (UnL). All taught-in devices are deleted simultaneously.



In the MAX! House solution you can configure the settings for the MAX! Radiator Thermostat+ via the MAX! software.



In the MAX! Room solution you can configure the settings for the MAX! Radiator Thermostat+ via the MAX! Wall Thermostat+.



If you use the MAX! Radiator Thermostat+ in the MAX! Radiator solution, proceed as follows:

- Press the Auto/Manu button longer than 3 seconds.
- Select the menu item „UnL“ with the handwheel and confirm with the Boost button.
- „ACC“ appears in the display. Confirm with the Boost button to delete all taught-in devices.

10.10 RESTORING THE FACTORY SETTINGS (RES)

The factory settings of the MAX! Radiator Thermostat+ can be restored manually. This means that all the manually performed settings are lost.



In the MAX! House solution you can configure the settings for the MAX! Radiator Thermostat+ via the MAX! software. Before restoring the factory settings of the MAX! Radiator Thermostat+, first delete the device from the local MAX! software if you use the radiator thermostat in connection with a MAX! Cube.



In the MAX! Room solution you can configure the settings for the MAX! Radiator Thermostat+ via the MAX! Wall Thermostat+.



If you use the MAX! Radiator Thermostat+ in the MAX! Radiator solution, proceed as follows:

- Press the Auto/Manu button longer than 3 seconds.
- Select the menu item „rES“ with the handwheel and confirm with the Boost button.

- „ACC“ appears in the display. Confirm with the Boost button to reset the device.



If you have taught-in several MAX! Radiator Thermostats or MAX! Window Sensors, all devices have to be reset.

11 CHILD SAFEGUARD/OPERATING LOCK

Basic child safeguard/operating lock

Operation of the device can be locked to avoid settings being changed unintended (e.g. through involuntary touch).

- To activate/deactivate the basic operating lock, press and immediately release the Auto/Manu and (☼) buttons simultaneously.
- Once activated, the operating lock symbol (🔒) is shown on the display for 10 s.. Afterwards, the symbol will be displayed permanently. Operation of the device is now locked.
- To deactivate the operating lock, press both buttons once again.

Advanced child safeguard/operating lock function (Loc)

The advanced operating lock provides enhanced security for the operation of the MAX! Radiator Thermostat+ with the entry of a four-digit code. When the advanced operating lock is activated on the MAX! Radiator Thermostat+, the device switches to auto mode automatically and operation is reduced to adjusting the temperature using the handwheel and/or the comfort (☼) and reduction temperature buttons

(C). The adjustable temperature range is also restricted. The minimum and maximum temperature upper limits are between 5.0 °C and 24.0 °C.

The advanced operating lock is deactivated in the initial state.

Activating the operating lock:

- Press the Auto/Manu button longer than 3 seconds. Select the menu item „Loc“ with the handwheel and confirm with the Boost button.
- Next, enter the default four-digit code 1357. Use the handwheel to select each digit one after the other. Once you have selected the correct digits, press the Boost button to confirm. The cursor moves to the next digit automatically.
- After you have selected the correct code, "ON" or "OFF" is displayed. Select the required state using the handwheel. "On" means that the advanced operating lock is activated. "OFF" deactivates the operating lock. Select "ON" and press the Boost button to confirm your selection.
- The advanced operating lock is now activated and the  - symbol is displayed.
- If you enter an incorrect code, the display switches back to normal immediately.

Deactivating the operating lock:

- If the  - symbol is displayed, the advanced operating lock is activated.
- Press the Auto/Manu button longer than 3 seconds to deactivate the lock.
- Enter the default four-digit code. Use the handwheel to select each digit one after the other. Press the Boost but-

ton to confirm the correct digits.

- After you have selected the correct code, "ON" or "OFF" is displayed. Select "OFF" with the handwheel and press the Boost button to confirm.
- The display returns to normal. The -symbol is off and the advanced operating lock is deactivated.
- If you enter an incorrect code, the display switches back to normal immediately. The advanced operating lock continues to be activated.



If you have taught-in several radiator thermostats the operating lock has to be activated and deactivated manually on each device.

Changing the code:

- Press the Auto/Manu button longer than 3 seconds. Select the menu item „Loc“ with the handwheel and confirm with the Boost button.
- Enter the code stored in the memory as described above. "ON" or "OFF" is displayed.
- Press the Auto/Manu button again.
- Use the handwheel to change each of the four digits in the code one after the other. Confirm your selection with the Boost button. The new code and "ON" or "OFF" are now displayed.
- Once you have selected all four digits, press the Boost button. Your code has now changed and the display reverts to the normal view.



If you forget the code, the full functional scope of the MAX! Radiator Thermostat+ can only be restored by

performing a factory reset or via the MAX! Cube (see sec. „13 Restore factory settings“ on page 44). The code can only be changed on the device itself and not via the local MAX! software.

12 ACTIVATE HEATING PAUSE (BATTERY SAVING)

Battery life can be prolonged by switching the heating off in summer. To achieve this, the valve is opened fully. The calcification protection continues to run.



In the MAX! House solution you can configure the settings for the MAX! Radiator Thermostat+ via the MAX! software.



In the MAX! Room solution you can configure the settings for the MAX! Radiator Thermostat+ via the MAX! Wall Thermostat+.



If you use the MAX! Radiator Thermostat+ in the MAX! Radiator solution, proceed as follows:

- Press the Auto/Manu button until Manu appears in the display.
- In manual mode (Manu), turn the handwheel clockwise until "On" is displayed.
- To save changes and leave manual mode, press the Auto/Manu button again.

12.1 **ACTIVATING FROST PROTECTION OPERATION (RADIATOR SWITCHED OFF)**

If the room does not need to be heated, the valve can be closed. The valve is only opened if there is a risk of frost. The calcification protection continues to run.



In the MAX! House solution you can configure the settings for the MAX! Radiator Thermostat+ via the MAX! software.



In the MAX! Room solution you can configure the settings for the MAX! Radiator Thermostat+ via the MAX! Wall Thermostat+.



If you use the MAX! Radiator Thermostat+ in the MAX! Radiator solution, proceed as follows:

- Press the Auto/Manu button until Manu appears in the display.
- In manual mode (Manu), turn the handwheel anticlockwise until "OFF" is displayed.
- To save changes and leave manual mode, press the Auto/Manu button again.

13 **RESTORE FACTORY SETTINGS**

The factory settings of the MAX! Radiator Thermostat+ can be restored manually. Restoring the factory settings deletes all settings and information about taught-in devices.





Before restoring the factory settings of the MAX! Radiator Thermostat+, first delete the device from the local MAX! software if you use the radiator thermostat in connection with a MAX! Cube.

- Remove the batteries from the battery compartment.
- Wait 60 seconds.
- Press and hold down the three buttons (Auto/Manu, Boost, ) while inserting the batteries.
- Once the factory settings have been restored successfully, "rES" is displayed.

14 LED FLASHING SEQUENCES AND TRANSMISSION BEHAVIOUR

Error code on the display	Problem	Solution
Empty battery symbol 	Battery voltage too low	Replace batteries
F1	Valve drive sluggish	Check the installation; check whether the pin on the heating valve is stuck
F2	Actuating range too wide	Check the fastening of the radiator thermostat
F3	Adjustment range too small	Check the heating valve; check whether the valve pin is jammed
F4	Device already taught-in to a MAX! Cube or MAX! Wall Thermostat+	Make sure the device is no longer taught-in to the MAX! Cube (in the software) or the MAX! Wall Thermostat+ and restore the factory settings. Then you can teach-in the device again.

F5	Temperature sensor defective	Device defective - please contact your specialist dealer.
F6	Battery voltage too low, valve moved to error position	Replace the batteries of the radiator thermostat
Slowly flashing antenna symbol ()	Connection to taught-in MAX! components lost	Check the power supply and the batteries of taught-in MAX! components.
Quickly flashing antenna symbol ()	Duty cycle limit reached	The device can resume radio communication after a waiting time of approx. one hour
CAL	Routine descaling is active	Automatic function (see sec. „10.5 Setting routine descaling (dEC)” on page 35)

15 MAINTENANCE AND CLEANING

The product does not require any maintenance. Enlist the help of an expert to carry out any repairs. Clean the product using a soft, lint-free cloth that is clean and dry. You may dampen the cloth a little with lukewarm water in order to remove more stubborn marks. Do not use any detergents containing solvents, as they could corrode the plastic housing and label.

16 INFORMATION ABOUT RADIO OPERATION

Radio transmission is performed on a non-exclusive transmission path, which means that there is a possibility of interference occurring. Interference can also be caused by switching operations, electrical motors or defective electrical devices.

 The range of transmission within buildings can differ greatly from that available in the open air. Besides the transmitting power and the reception characteristics of the receiver, environmental factors such as humidity in the vicinity have an important role to play, as do on-site structural/screening conditions.

eQ-3 AG hereby declares that this device complies with the essential requirements and other relevant regulations of Directive 1999/5/EC. You can find the full declaration of conformity at www.eQ-3.de.

17 TECHNICAL SPECIFICATIONS

Device short description:	BC-RT-TRX-CyG-4
Supply voltage:	2x 1.5 V LR6/mignon/AA
Current consumption:	100 mA (max.)
Battery life:	2 years (typ.)
Display:	LCD
Radio frequency:	868.3 MHz
Typ. open area RF range:	> 100 m
Receiver category:	SRD category 2
Duty cycle:	< 1 % per h
Method of operation:	Type 1
Degree of protection:	IP20
Ambient temperature:	0 to 50 °C
Dimensions (W x H x D):	60 x 65 x 100 mm
Weight:	170 g (not incl. batteries)
Connection:	M30 x 1.5 mm
Linear travel:	4.2 mm
Spring force:	80 N (typ.)

Subject to technical changes.

Max. number of devices to be taught-in:

MAX! House solution

- max. 50 devices in max. 10 rooms,
- max. 4 MAX! Eco Switch
- per room max. 8 MAX! Radiator Thermostats(+), 8 MAX! Window Sensors and 1 MAX! Wall Thermostat+

MAX! Room solution:

- max. 1 MAX! Wall Thermostat+
- max. 8 MAX! Radiator Thermostats(+)
- max. 8 MAX! Window Sensors

MAX! Radiator solution

- max. 2 MAX! Radiator Thermostat+
- max. 3 MAX! Window Sensors



Do not dispose of the device with regular domestic waste.

Electronic equipment must be disposed of at local collection points for waste electronic equipment in compliance with the Waste Electrical and Electronic Equipment Directive.



The CE sign is a free trading sign addressed exclusively to the authorities and does not include any warranty of any properties.



For technical support, please contact your specialist dealer.



Bevollmächtigter des Herstellers:
Manufacturer's authorised representative:

eQ-3

eQ-3 AG
Maiburger Straße 29
26789 Leer / GERMANY
www.eQ-3.de